

# Photoelectrics Retro-reflective Type PA18CLR30T, AC, PBTP housing

CARLO GAVAZZI



- Range: 3 m
- Modulated infrared light
- Supply voltage: 20 to 250 VAC
- Output: 500 mA SCR
- Make and break switching functions
- LED output indication
- High immunity to ambient light
- Cable and plug versions



## Product Description

The PA18CLR.. is a family of inexpensive general purpose Retro-reflective sensors in industrial standard 18 mm cylindrical PBTP housing. They are useful for simple applications where a basic

sensor provides adequate sensing performance. The sensors are simple to use and no adjustment are necessary. The output is a 2-wire NO or NC thyristor (SCR) output.

## Ordering Key

**PA18CLR30TOM6**

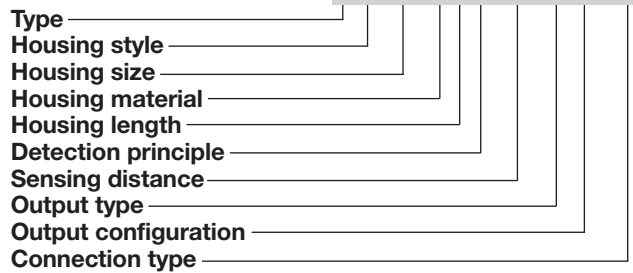

## Type Selection

Housing diameter	Rated operating dist. (S <sub>n</sub> )	Ordering no. SCR/Cable Make switching	Ordering no. SCR/Plug Make switching	Ordering no. SCR/Cable Break switching	Ordering no. SCR/Plug Break switching
M18	3 m	PA18CLR30TO	PA18CLR30TOM6	PA18CLR30TC	PA18CLR30TCM6

**Note:** Plugs and reflectors to be ordered separately

## Specifications

<b>Rated operating dist. (S<sub>n</sub>)</b>	Up to 3 m Ref. reflector type ER4, Ø 84 mm	<b>Operating frequency (f)</b>	Max. 20 Hz, light/dark ratio 1:2
<b>Temperature drift</b>	0.4%/K	<b>Response time</b> OFF-ON (t <sub>ON</sub> ) ON-OFF (t <sub>OFF</sub> )	≤ 20 ms ≤ 30 ms
<b>Hysteresis (H)</b> (Differential travel)	3 to 20%	<b>Power ON delay (t<sub>v</sub>)</b>	Typ. 100 ms
<b>Rated operational volt. (U<sub>b</sub>)</b>	20 to 250 VAC, 45 to 65 Hz	<b>Indication function</b> Output ON	Dark (NC) or light (NO) switching LED, yellow
<b>Output current (AC 12, AC 140)</b> Continuous (I <sub>e</sub> ) Short-time (I)	≤ 500 mA ≤ 3 A, max. 20 ms	<b>Environment</b> Overvoltage category Pollution degree Degree of protection	III (IEC 60664/60664A; 60947-1) 3 (IEC 60664/60664A; 60947-1) IP 67 (IEC 60529; 60947-1)
<b>Min. operational current (I<sub>m</sub>)</b>	10 mA	<b>Temperature</b> Operating Storage	-20° to +60°C (-4° to 140°F) -30° to +70°C (-22° to 158°F)
<b>OFF-state current (I<sub>r</sub>)</b>	< 5 mA, typ. 2.6 mA	<b>Vibration</b>	10 to 150 Hz, 0.5 mm/- 7.5 g (IEC 60068-2-6)
<b>Voltage drop (U<sub>d</sub>)</b>	≤ 10 VAC, typ. 7 VAC	<b>Shock</b>	2 x 1 m 100 x 0.5 m (IEC 60068-2-32)
<b>Protection</b>	Transients	<b>Dielectric voltage</b>	1600 V (IEC 60364-4-41)
<b>Transient voltage</b>	1 kV/0.5 J		
<b>Light source</b>	GaAlAs LED, 880 nm		
<b>Light type</b>	Infrared, modulated		
<b>Optical angle</b>	± 2.2°		
<b>Light spot size</b>	150 mm at 2 m		
<b>Ambient light</b>	Max. 10,000 lux		



## Specifications (cont.)

<b>Housing material</b>	
Body	PBTP grey thermoplastic polyester Luran®, black
Front	Polyester, black
Cable end	Reinforced nylon
Nuts	
<b>Connection</b>	
Cable	Grey, 2 m, 2 x 0.5 mm <sup>2</sup> , oilproof PVC
Plug	M12 x 1
Cables for plug (M6)	CON.6A-.. serie
<b>Weight</b>	
Cable version	105 g
Plug version	22 g
<b>Approvals</b>	
	UL, CSA
<b>CE-marking</b>	
	Yes

## Dimensions

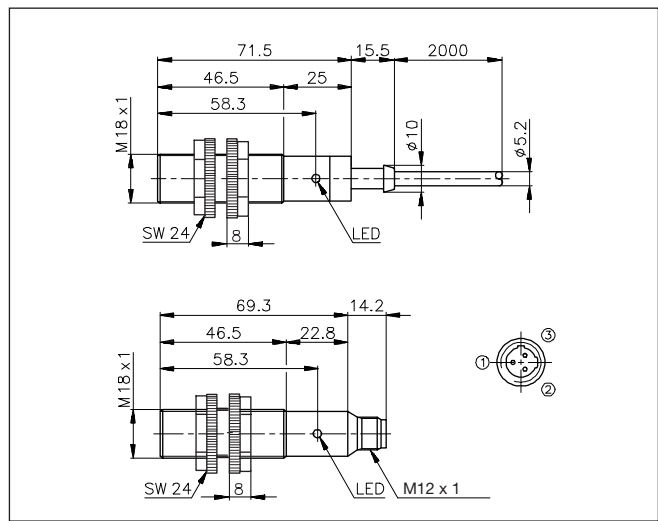

## Operation Diagram

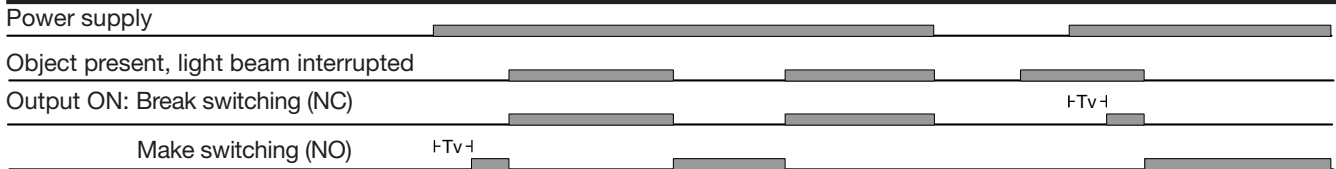

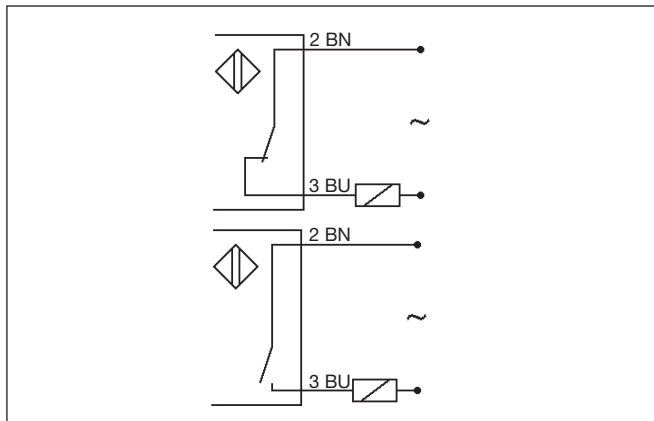

## Wiring Diagrams

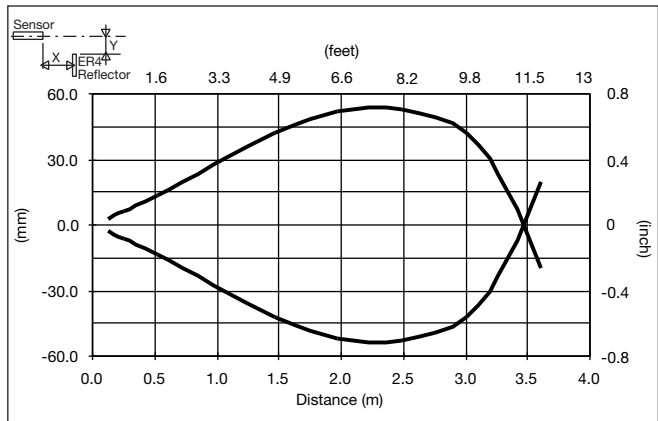

## Detection Diagram

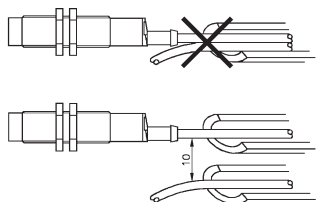

## Installation Hints

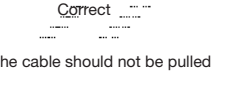
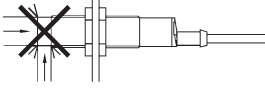
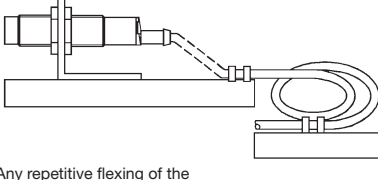
<p>To avoid interference from inductive voltage/current peaks, separate the prox. switch power cables from any other power cables, e.g. motor, contactor or solenoid cables</p> 	<p>Relief of cable strain</p> <p><b>Incorrect</b></p>  <p><b>Correct</b></p>  <p>The cable should not be pulled</p>	<p>Protection of the sensing face</p>  <p>A proximity switch should not serve as mechanical stop</p>	<p>Switch mounted on mobile carrier</p>  <p>Any repetitive flexing of the cable should be avoided</p>
---	---	--	--

## Delivery Contents

- Photoelectric switch: PA18CLR30T.
- 2 nuts
- **Packaging:** plastic bag

## Accessories

- Reflectors: ER series
- Connector type CON.6A-.. serie
- MB18A
- APA18-RAR

For further information refer to "Accessories"

# Mouser Electronics

Authorized Distributor

Click to View Pricing, Inventory, Delivery & Lifecycle Information:

[Carlo Gavazzi:](#)

[PA18CLR30TOM6](#) [PA18CLR30TC](#) [PA18CLR30TCM6](#) [PA18CLR30TO](#)